



Coimisiún na Scrúduithe Stáit

An tSraith Shóisearach, 2022

**Aistriúchán
Ar Scéim Mharcála**

Grafaic

Comhleibhéal

Nóta do mhúinteoirí agus do scoláirí faoi úsáid na scéimeanna marcála foilsithe

Níl na scéimeanna marcála a fhoilsíonn Coimisiún na Scrúduithe Stáit ceaptha lena n-úsáid mar cháipéisí astu féin. Is áis riachtanach iad ag scrúdaitheoirí a théann faoi oiliúint i léirléamh agus i gcur i bhfeidhm ceart na scéime. Mar chuid den oiliúint sin, as measc rudaí eile, déantar samplaí d'obair na scoláirí a mharcáil agus déantar plé ar na marcanna a bhronntar, mar mhaithe le cur i bhfeidhm ceart na scéime a shoiléiriú. Déanann Scrúdaitheoirí Comhairleacha monatóireacht ar obair na scrúdaitheoirí ina dhiaidh sin le cinntiú go gcuirtear an scéim mharcála i bhfeidhm go comhleanúnach agus go beacht. Bíonn an Príomhscrúdaitheoir i bhfeighil an phróisis agus is gnách go mbíonn Príomhscrúdaitheoir Comhairleach ag cuidiú leis. Is é an Príomhscrúdaitheoir an t-údarás deiridh i dtaca le cé acu a cuireadh an scéim mharcála i bhfeidhm i gceart ar aon phíosa d'obair iarrthóra nó nár cuireadh.

Is cáipéisí oibre na scéimeanna marcála. Cé go n-ullmhaítear dréachtscéim mharcála roimh an scrúdú, ní chuirtear bailchríoch uirthi go dtí go gcuireann scrúdaitheoirí i bhfeidhm ar obair iarrthóirí í agus go dtí go mbailítear agus go meastar an t-aiseolas ó na scrúdaitheoirí uile, i bhfianaise raon iomlán na bhfreagraí a thug na hiarrthóirí, leibhéal foriomlán deacrachta an scrúdaithe agus an ghá le comhleanúnachas caighdeán a choimeád ó bhliain go bliain. Aistriúchán ar an scéim chríochnaithe atá sa cháipéis foilsithe seo, mar a cuireadh i bhfeidhm ar obair na n-iarrthóirí uile í.

Is cóir a nótáil i gcás scéimeanna ina bhfuil freagraí nó réitigh eiseamláireacha nach bhfuil sé i gceist a chur in iúl go bhfuil na freagraí ná na réitigh sin uileghabhálach. D'fhéadfadh sé go bhfuil leaganacha éagsúla nó malartacha ann a bheadh inghlactha freisin. Ní mór do na scrúdaitheoirí tuilleanas gach freagra a mheas agus téann siad i gcomhairle lena Scrúdaitheoirí Comhairleacha nuair a bhíonn amhras orthu.

Scéimeanna Marcála san am atá le teacht

Ní cóir talamh slán a dhéanamh d'aon rud a bhaineann le scéimeanna marcála san am atá le teacht bunaithe ar scéimeanna a bhí ann cheana. Cé go mbíonn na bunphrionsabail mheasúnachta mar an gcéanna, is féidir go mbeadh athrú ar shonraí marcála cineál áirithe ceiste i gcomhthéacs na páirte a bheadh ag an gceist sin sa scrúdú foriomlán bliain áirithe ar bith. Bíonn sé de fhreagracht ar an bPríomhscrúdaitheoir bliain áirithe ar bith a dhéanamh amach cén tslí is fearr a chinnteoidh go measfar obair na n-iarrthóirí go cothrom agus go cruinn, agus go gcoimeádfar caighdeán comhleanúnach measúnachta ó bhliain go bliain. Dá réir sin, d'fhéadfadh gnéithe de struchtúr, de mhionsonraí agus de chur i bhfeidhm na scéime marcála in ábhar áirithe athrú ó bhliain go bliain gan rabhadh.



Coimisiún na Scrúduithe Stáit
State Examinations Commission

Scrúdú na Sraithe Sóisearaí 2022

Grafaic
Comhleibhéal

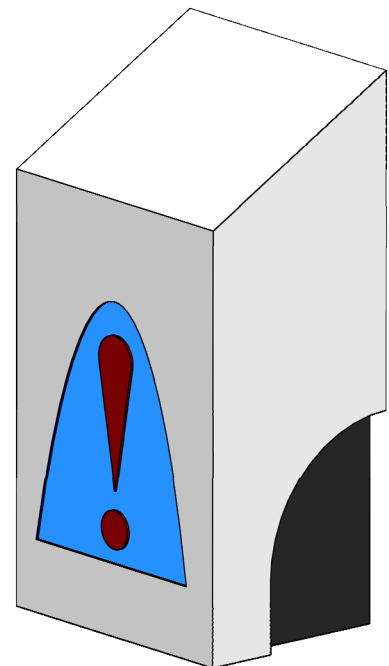
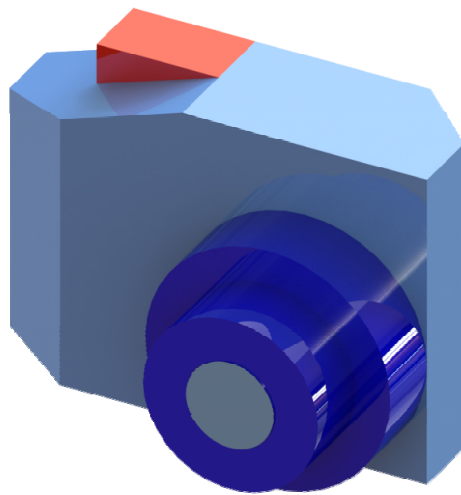
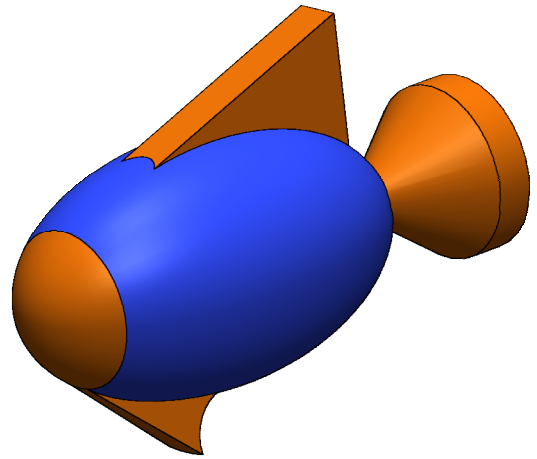





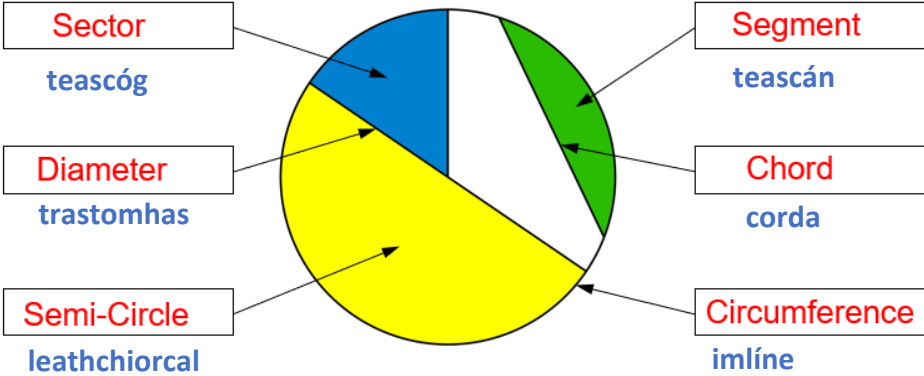
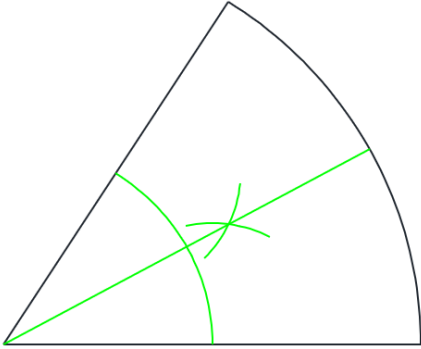
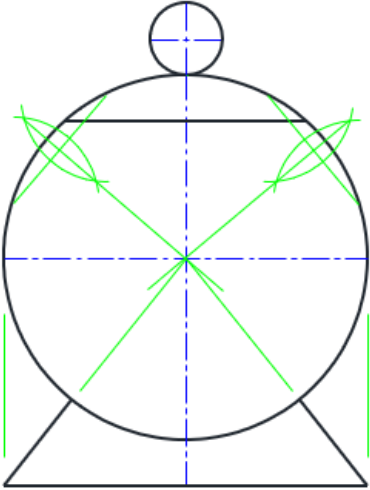











Scéim Marcála

Freagair gach ceist.

Ceist 1.		
C1 (a)	12	<p>(2 mharc an ceann)</p> 
C1 (b)	6 2	<p>(i) Uillinn a dhéoinnt (6 mharc)</p> <p>(ii) 6 (2 mharc)</p> 
C1 (c)	4 4 3	<p>Lárphointe ceart (4 mharc)</p> <p>4 líne (4 x 1 mharc)</p> <p>Ciorcal (3 mharc) Lárphointe ar bith 1 mharc</p> 
Lch. 2 san Iomlán	31	

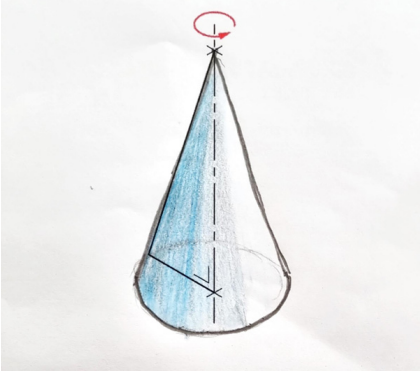
Ceist 2

<p>C2 (a)</p>	<p>8</p>	<p>(2 mharc an ceann)</p> <table border="1" style="width: 100%; border-collapse: collapse;"> <tbody> <tr> <td style="text-align: center;"></td> <td> Ainm: _____ Sorcóir <input checked="" type="checkbox"/> Ciúb <input type="checkbox"/> </td> </tr> <tr> <td style="text-align: center;"></td> <td> Ainm: _____ Cón <input checked="" type="checkbox"/> Ciúbóideach <input type="checkbox"/> </td> </tr> <tr> <td style="text-align: center;"></td> <td> Ainm: _____ Triantán <input type="checkbox"/> Pirimid <input checked="" type="checkbox"/> </td> </tr> <tr> <td style="text-align: center;"></td> <td> Ainm: _____ Sféar <input type="checkbox"/> Leathsféar <input checked="" type="checkbox"/> </td> </tr> </tbody> </table>		Ainm: _____ Sorcóir <input checked="" type="checkbox"/> Ciúb <input type="checkbox"/>		Ainm: _____ Cón <input checked="" type="checkbox"/> Ciúbóideach <input type="checkbox"/>		Ainm: _____ Triantán <input type="checkbox"/> Pirimid <input checked="" type="checkbox"/>		Ainm: _____ Sféar <input type="checkbox"/> Leathsféar <input checked="" type="checkbox"/>					
	Ainm: _____ Sorcóir <input checked="" type="checkbox"/> Ciúb <input type="checkbox"/>														
	Ainm: _____ Cón <input checked="" type="checkbox"/> Ciúbóideach <input type="checkbox"/>														
	Ainm: _____ Triantán <input type="checkbox"/> Pirimid <input checked="" type="checkbox"/>														
	Ainm: _____ Sféar <input type="checkbox"/> Leathsféar <input checked="" type="checkbox"/>														
<p>C2 (b)</p>	<p>6</p>	<p>(2 mharc an ceann)</p> <table style="width: 100%;"> <thead> <tr> <th></th> <th style="text-align: center;">Fíor</th> <th style="text-align: center;">Bréagach</th> <th rowspan="4" style="text-align: center;"></th> </tr> </thead> <tbody> <tr> <td>(i) In ingearchló, bíonn cuma ciorcail ar sféar.</td> <td style="text-align: center;"><input checked="" type="checkbox"/></td> <td style="text-align: center;"><input type="checkbox"/></td> </tr> <tr> <td>(ii) I mbonnchló, bíonn cuma ciorcail ar sféar.</td> <td style="text-align: center;"><input checked="" type="checkbox"/></td> <td style="text-align: center;"><input type="checkbox"/></td> </tr> <tr> <td>(iii) I gcló ísiméadrach, bíonn cuma éilips ar sféar.</td> <td style="text-align: center;"><input type="checkbox"/></td> <td style="text-align: center;"><input checked="" type="checkbox"/></td> </tr> </tbody> </table>		Fíor	Bréagach		(i) In ingearchló, bíonn cuma ciorcail ar sféar.	<input checked="" type="checkbox"/>	<input type="checkbox"/>	(ii) I mbonnchló, bíonn cuma ciorcail ar sféar.	<input checked="" type="checkbox"/>	<input type="checkbox"/>	(iii) I gcló ísiméadrach, bíonn cuma éilips ar sféar.	<input type="checkbox"/>	<input checked="" type="checkbox"/>
	Fíor	Bréagach													
(i) In ingearchló, bíonn cuma ciorcail ar sféar.	<input checked="" type="checkbox"/>	<input type="checkbox"/>													
(ii) I mbonnchló, bíonn cuma ciorcail ar sféar.	<input checked="" type="checkbox"/>	<input type="checkbox"/>													
(iii) I gcló ísiméadrach, bíonn cuma éilips ar sféar.	<input type="checkbox"/>	<input checked="" type="checkbox"/>													
<p>C2 (c)</p>	<p>16</p>	<p>(8 marc an ceann) 6 mharc don sceitse, 2 mharc do rindreáil cuí</p> <div style="display: flex; justify-content: space-around;">   </div>													
<p>Lch. 3 san Iomlán</p>	<p>30</p>														

Ceist 3

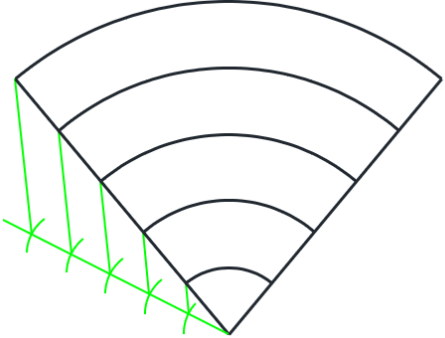
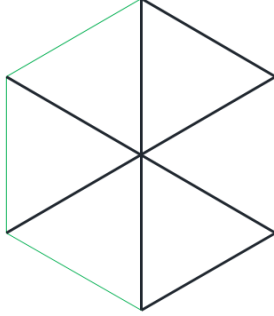
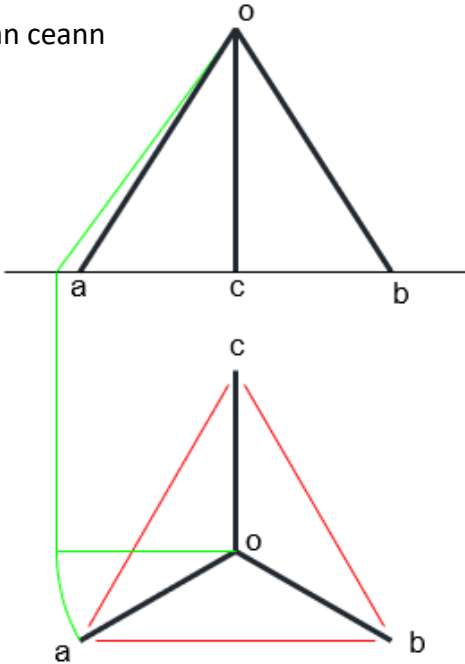
<p>C3 (a)</p>	<p>4</p>	<p>(4 mharc)</p> 
<p>C3 (b)</p>	<p>3 4</p>	<p>Roinnt na líne (3 mharc)</p> <p>Stuanna (4 mharc)</p> 
<p>C3 (c)</p>	<p>3 4</p>	<p>Tógáil ceart (3 mharc)</p> <p>Críochnú an lógó (4 mharc) – 1 mharc in aghaidh na líne</p> 
<p>C3 (d)</p>	<p>4 3</p>	<p>Innéacsú ceart (4 mharc) – 1 mharc an ceann</p> <p>Fad ceart na líne (3 mharc)</p> 
<p>Lch. 4 san Iomlán</p>	<p>25</p>	

Ceist 3 ar lean

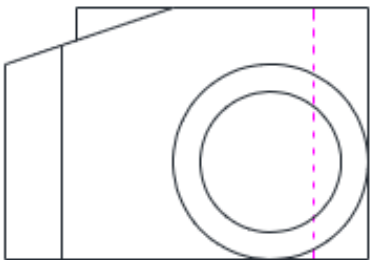
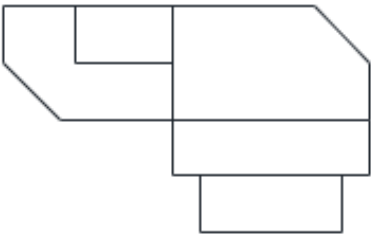
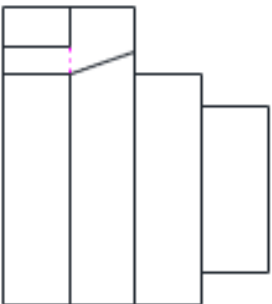
Ceist 3 ar lean		
C3 (e) (i)	Ingearchló (13)	
6	Imlíne an cheamara – 6 líne (6 x 1 mharc)	
2	Imlíne an chnaipe – 2 líne (2 x 1 mharc)	
4	Imlíne an lionsa – (4mharc) 1 ar gach suíomh, 1 ar gach ciorcal	
1	Mionsonra folaithe – 1 líne (1 mharc)	
C3 (e) (ii)	Plean (15)	
7	Imlíne an cheamara – 7 líne (7 x 1 mharc)	
2	Imlíne an chnaipe – 2 líne (2 x 1 mharc)	
6	Imlíne an lionsa – 6 líne (6 x 1 mharc)	
C3 (e) (iii)	Taobhchló (16)	
7	Imlíne an cheamara – 7 líne (7 x 1 mharc)	
2	Imlíne an chnaipe – 2 líne (2 x 1 mharc)	
6	Imlíne an lionsa – 6 líne (6 x 1 mharc)	
1	Mionsonra folaithe – 1 líne (1 mharc)	
C3 (e) (iv)	Fíor-chruth (6)	
6	Leithead a fháil amach (2), Airde a fháil amach (2), Críochnú (2)	
	3	Cur i Láthair (3 mharc)
Lch. 5 san Iomlán	53	

Ceist 4

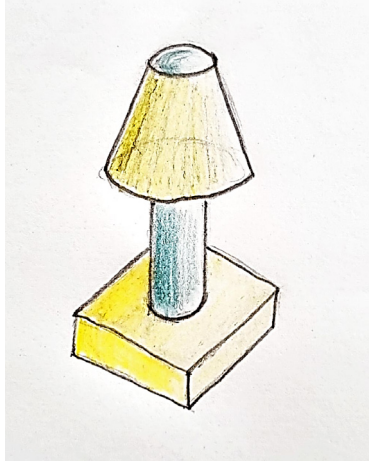
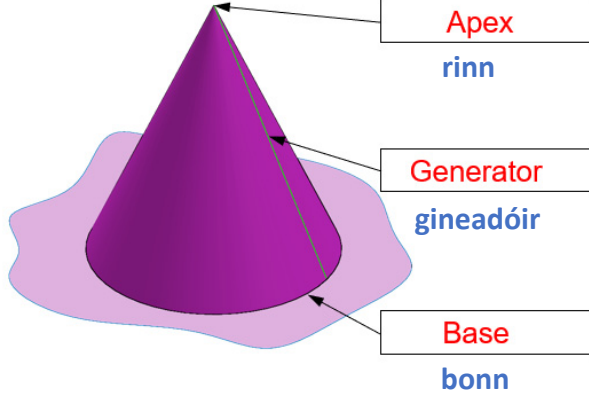
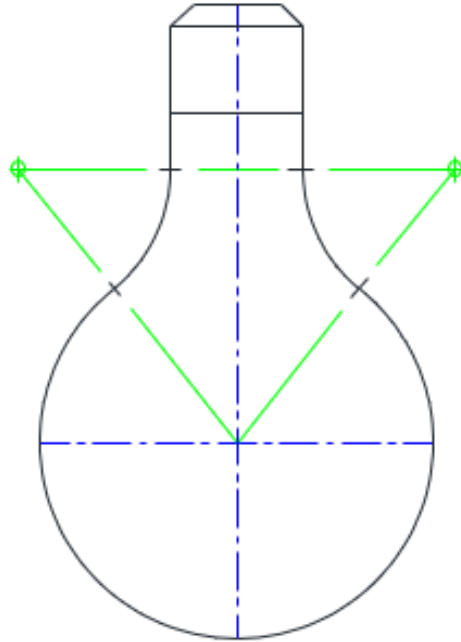
<p>C4 (a)</p>	<p>6</p>	<p>(6 mharc) 4 mharc don sceitse 2 mharc don rindreáil cuí</p>	
<p>C4 (b)</p>	<p>6</p>	<p>(2 mharc an ceann)</p>	
<p>C4 (c)</p>	<p>7 6 2</p>	<p>7 líne (7 x 1 mharc) 3 stua (2 mharc an ceann) Pointí teagmhála (2 mharc)</p>	
<p>Lch. 6 san lomlán</p>	<p>27</p>		

Ceist 5

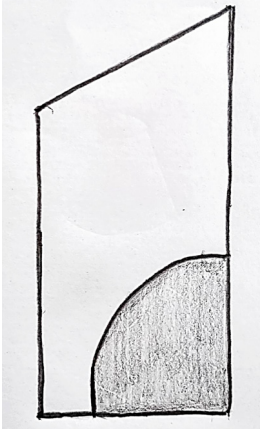
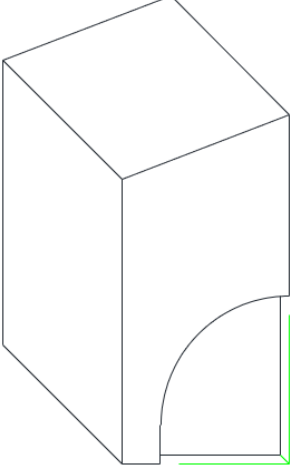
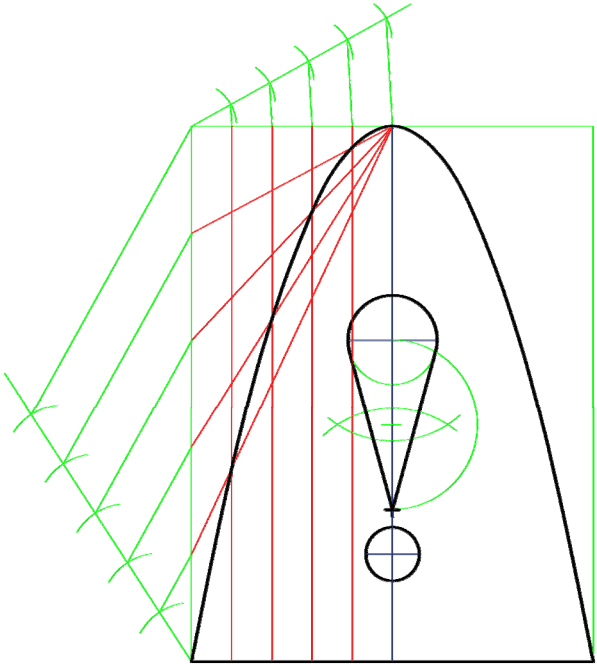
<p>C5 (a)</p>	<p>6</p>	<p>(6 mharc)</p>	
<p>C5 (b)</p>	<p>10</p>	<p>5 líne (5 x 2 mharc)</p>	
<p>C5 (c)</p>	<p>6 6</p>	<p>Tógáil parabóile (1,1,1,1) cuar a tharraingt (2 mharc)</p> <p>Tógáil tadhlaí (4 mharc) Tadhlaithe a tharraingt (1 mharc an ceann)</p>	
<p>Lch. 7 san lomlán</p>	<p>28</p>		

Ceist 5 ar lean

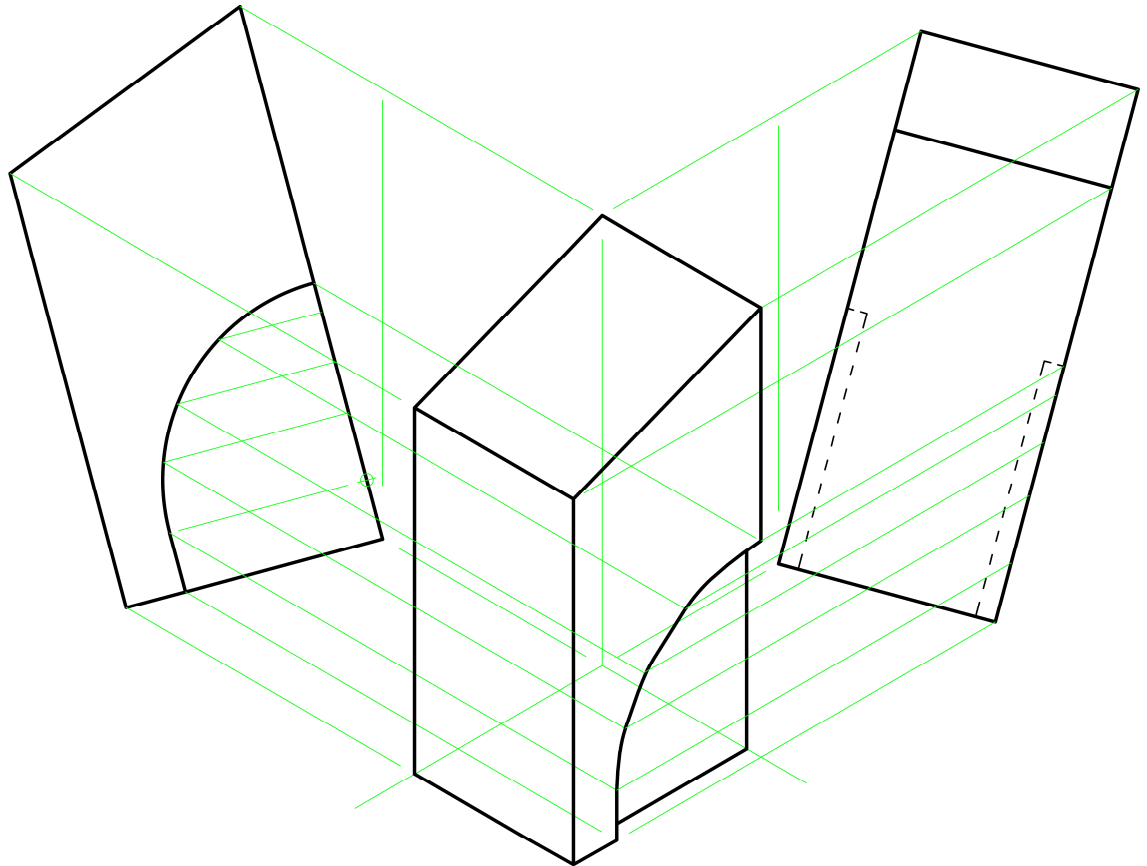

C5 (d)	6	3 líne ceartingearach (2 mharc an ceann)
	6	3 líne cothrománach (2 mharc an ceann)
	4	2 líne claonta (2 mharc an ceann)
	2	Pointí breise ar an gcuar sa taobhchló (2 mharc)
	2	Pointí ar an gcuar a aithint san ingearchló (2 mharc)
	2	Pointí ar an gcuar a aimsiú san aismhéadrach (2 mharc)
	2	Cuar a tharraingt (2 mharc)
	3	Cur i Láthair (3 mharc)
Lch. 8 san Iomlán	27	

Ceist 6

<p>C6 (a)</p>	<p>6</p>	<p>(2 mharc an ceann)</p>	
<p>C6 (b)</p>	<p>8</p>	<p>(2 mharc an ceann)</p>	
<p>C6 (c)</p>	<p>2 4 3</p>	<p>Ciorcal a roinnt (2 mharc) Incrimint cheart a bhogadh as áit (4 mharc) Críochnaithe – 3 líne (1 mharc an ceann)</p>	
<p>Lch. 9 san Iomlán</p>	<p>23</p>		

Ceist 6 ar lean

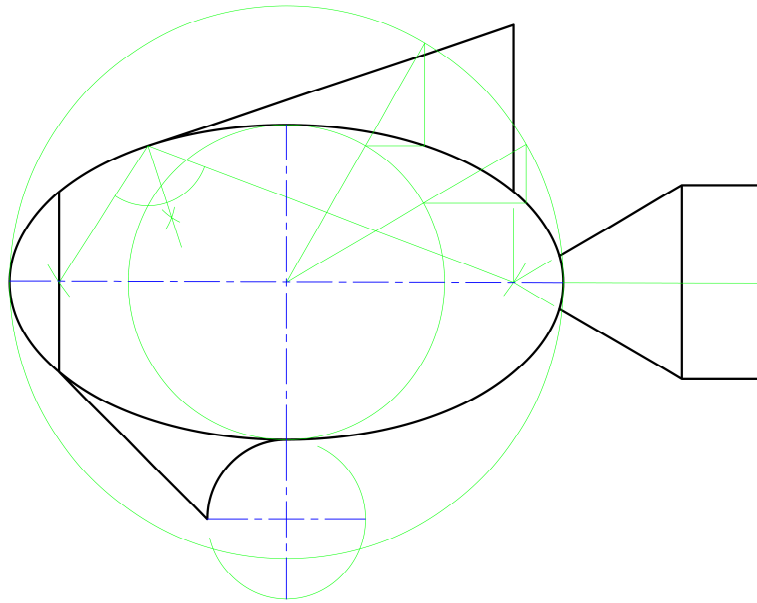

C6 (d) (i)	Éilips (14)	
	4	Mórchiorcal a tharraingt, Mionchiorcal a tharraingt (2,2)
	6	Pointí breise ar an gcuar a aimsiú (2,2,2)
	4	Cuar a tharraingt
C6 (d) (ii)	Tadhlaí agus Críochnú (19)	
	4	Suíomh ceart F_1 agus F_2 (2 x 2 mharc)
	3	Tógáil le haghaidh tadhlaí (3 mharc)
	2	Líne ceartingearach ó líne F_2 , Líne tadhlaí (1,1)
	2	Ciorcal (2 mharc)
	8	8 líne (1 mharc an ceann)
	3	Cur i Láthair (3 mharc)
Lch. 10 san Iomlán	36	
Iomlán 280		

Tionscadal an Dalta

scéim marcála

Bileog 1						
Sceitsí saorlámhe 2T agus 3T agus nótaí			Tuiscint ar an gcéimseata			Cur i láthair
20			12			8
Réasúnta	Maith	Sármhaith	Réasúnta	Maith	Sármhaith	
0 – 7	8 – 14	15 – 20	0 – 4	5 – 8	9 – 12	

Bileog 2						
Líníocht ortagrafach 2T atá mionsonraithe mar is cuí			Príomh-thoisí & gnásanna cuí 2T			Cur i láthair
20			12			8
Réasúnta	Maith	Sármhaith	Réasúnta	Maith	Sármhaith	
0 – 7	8 – 14	15 – 20	0 – 4	5 – 8	9 – 12	